

Circuit Protection Products

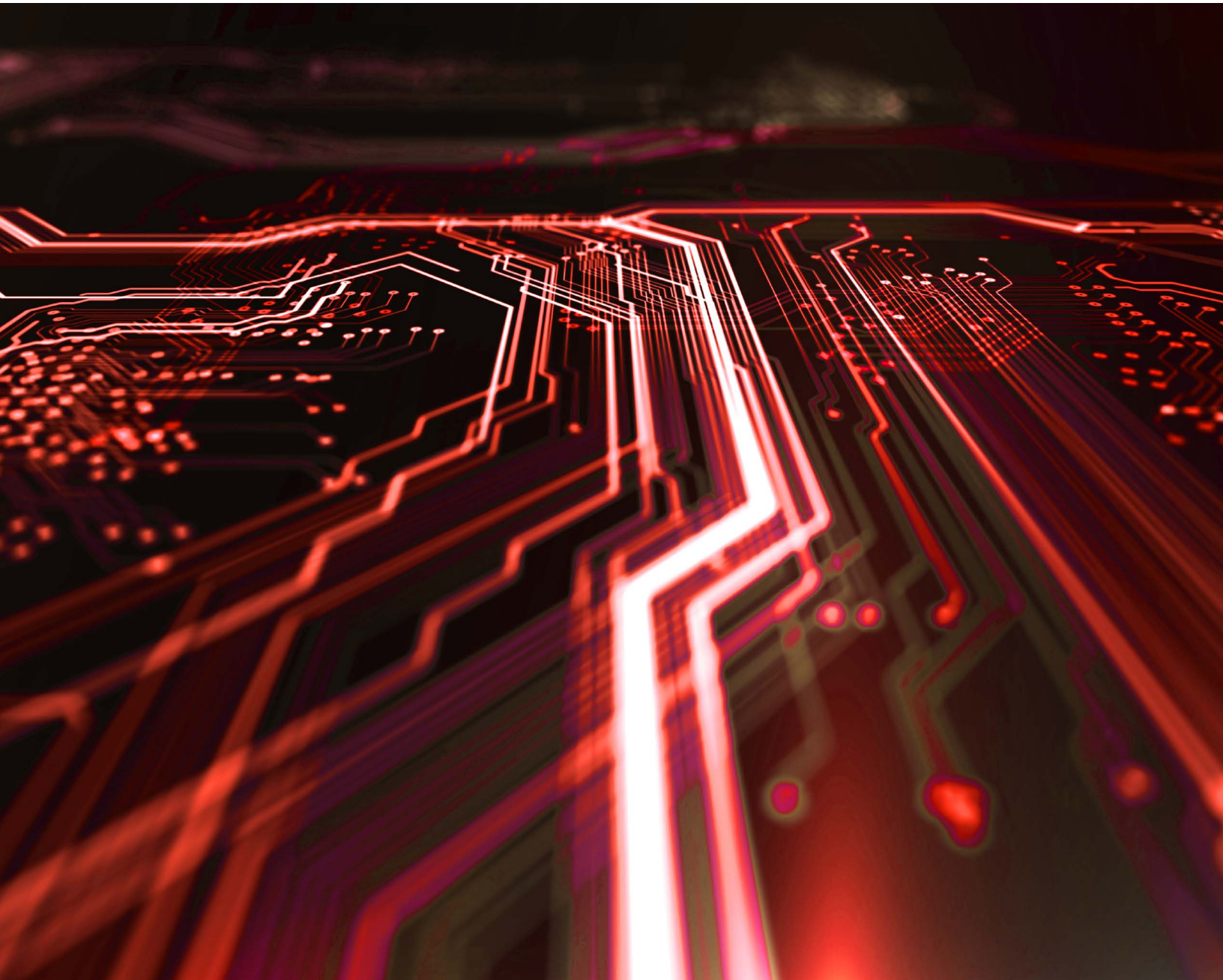

Industry leading HotSwitch[®], SurgeSwitch[™] and TVS Diode solutions to safeguard data interfaces from ESD and surge transients



HotSwitch®

Enhanced system protection solutions against transient and steady-state fault conditions

Features

- Integrated protection circuitry that can replace conventional fuses and other protection devices
- Delivers higher system reliability with safety features like overcurrent, overvoltage, over-temperature, and reverse current blocking
- With enhanced system dynamic behaviors, including limited inrush current, proper loading sequence, handling minor disturbances in a system power line, and injecting lesser interference among loads
- Ensures longer battery life for systems with low leakage and quiescent currents
- Provides lower BOM count and smaller PCB area than discrete or multi-chip solutions
- Embeds IEC 61000-4-2 level compliant ESD and surge protection for some applications

Enterprise



Servers



Storage



HDD



SSD



Sound Cards



POS Terminals

Industrial



Industrial Printer



Inkjet Printer



PLC



Low-end Robotics



Automation



3D Printer

Appliances



Dishwasher



Thermostats



Surveillance Camera



Vending Machine



Portable Refrigerator



E-Scooter

Motor



Drilling Machine



Blower



Air Compressor



Electric Saw

Consumer



USB-PD



Headphone



Drones



Power Bank

HotSwitch® Product Details

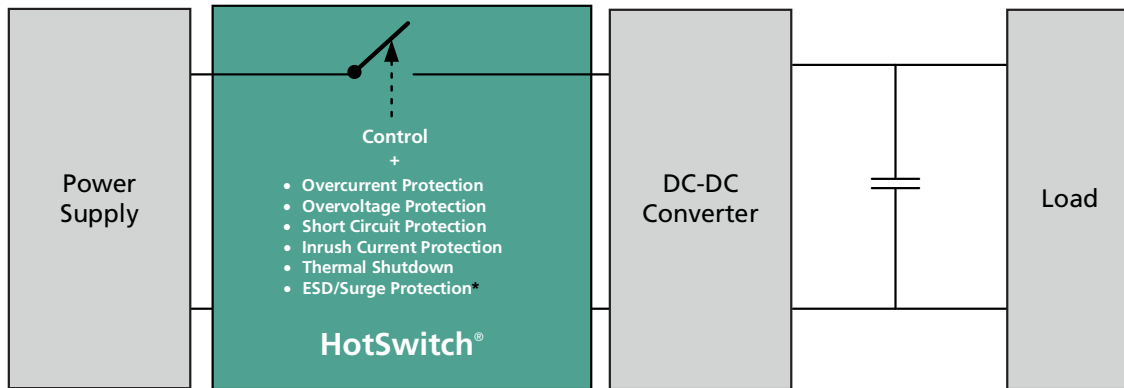

* Integrated in several eFuse parts

HotSwitch® Ordering Information

Part Number	Iq Typ (µA)	Shutdown Current Typ (µA)	Overcurrent Protection, Y/N	Current Limit (Fixed/Adj)	UVLO/Overvoltage Protection (Y/N)	Fault Signal (Y/N)	Soft Start	IEC61000-4-2 (ESD) Contact Rating (+/-kV)
HS2950P	340	1	Yes	Adj	Yes	Yes	Adj	
HS2240P	200	2	Yes	Fixed	Yes	Yes	Adj	12

Part Number	IEC61000-4-2 (ESD) Air Rating (+/-kV)	ESD Protection Level HBM (kV)	IEC 61000-4-5 (Lightning) (8/20µs)	Package	Package Size (mm)	Quantity per Reel	Reel Size
HS2950P		2	NA	DFN-12 lead	3.0x3.0x0.55	5000	13"
HS2240P	20	2	40A	DFN-14 lead	3.5x2.0x0.57	3000	7"

HS2950P

- Vin: 2.7V–29V
- Up to 5A DC Output Current
- Low $R_{DS(on)}$: 25mΩ
- Adjustable current limit
- Adjustable UVLO and overvoltage protection
- Automatic output discharge
- Programmable soft-start
- Fault flag
- Thermal shutdown protection
- DFN 3.0 x 3.0 x 0.55mm



29V 5A Load Protection HotSwitch

HS2240P

- Vin: 3.0V–22V Up to 5A DC Output Current
- Up to 3.1A DC Output Current
- Low $R_{DS(on)}$: 40mΩ
- Adjustable UVLO and overvoltage protection
- Automatic output discharge
- Programmable soft-start
- 40A Ipp (tp=8/20us) per IEC 61000-4-5
- ±20kV / ±12kV (air/contact) per IEC 61000-4-2
- Fault flag
- Thermal shutdown protection
- DFN 3.5 x 2.0 x 0.57mm

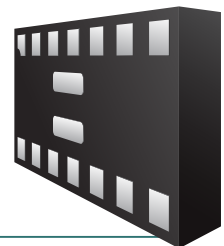

eFuse with Integrated SurgeSwitch™ Protection

SurgeSwitch™

The SurgeSwitch product line provides highly efficient protection against electrical overstress (EOS) and electrostatic discharge (ESD) events. These devices have superior clamping and stability over-temperature when compared to standard transient voltage suppression TVS devices.

Unlike TVS diodes, SurgeSwitch devices do not use a conventional PN junction for the breakdown mechanism. Instead, these devices employ a surge-rated FET with a driving circuit as the primary surge current shunting element, effectively working as voltage-controlled switches. A precisely tuned trigger circuit activates the shunt FET when an EOS event is detected. During an EOS event, transient voltage increases beyond the rated breakdown voltage of the device. The FET, in turn, switches on and safely diverts transient current to the ground to safeguard the integrated circuit. The operation of the SurgeSwitch is shown in Figure 1.

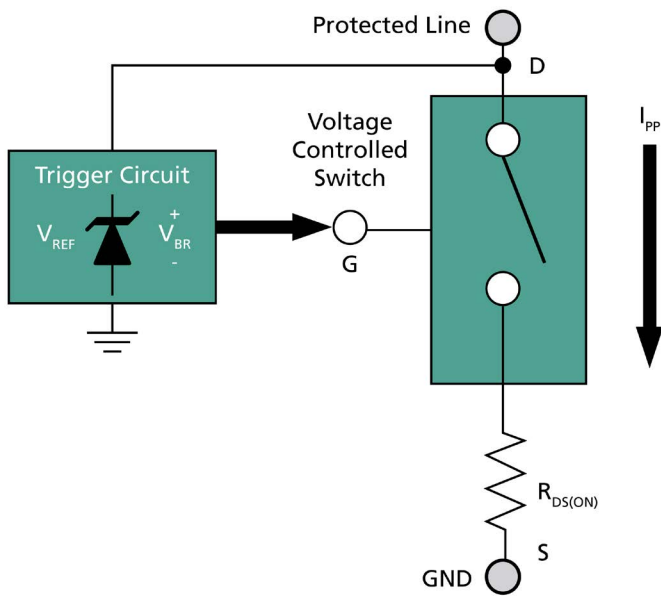

Figure 1. Operation of SurgeSwitch

Features

- Clamping voltage is nearly constant due to the extremely low On-Resistance of the FET
- Lower clamping voltage at maximum peak pulse current makes SurgeSwitch a suitable solution for protecting today's sensitive ICs
- Clamping voltage remains stable over the operating temperature range
- Clamping voltage of SurgeSwitch is typically 30% less than the clamping voltage seen with conventional TVS ESD protection devices

Applications

- USB Type-C
- Sensor
- Industrial IO-Link
- 4-20mA Current Loop
- PLC/DCS IO Module
- HVAC/24VAC Circuit
- Power Over Ethernet

SurgeSwitch™ Product Details

Semtech's SurgeSwitch devices are offered in several voltage options to address the needs of the consumer, industrial and telecom applications. Each device is housed in a small 1.6mm x 1.6mm package. The SurgeSwitch portfolio, provide surge immunity up to level 1 of the IEC61000-4-5 standard. These devices also provide ESD immunity above level 4 of the IEC61000-4-2 ESD Immunity standard.

1 Line Transient Diverting Suppressor for 22V EOS Protection

- 22V, 1-line protection
- 40A I_{pp} (tp=8/20us) per IEC 61000-4-5
- $\pm 30kV / \pm 30kV$ (air/contact)
- Constant clamping voltage across rate lpp range and temperature range
- DFN 1.6 x 1.6 x 0.55mm



TDS2211P



1 Line Transient Diverting Suppressor for 33V EOS Protection

- 33V, 1-line protection
- 35A I_{pp} (tp=8/20us) per IEC 61000-4-5
- $\pm 30kV / \pm 30kV$ (air/contact)
- Constant clamping voltage across rate lpp range and temperature range
- DFN 1.6 x 1.6 x 0.55mm



TDS3011P



1 Line Transient Diverting Suppressor for 45V EOS Protection

- 45V, 1-line protection
- 24A I_{pp} (tp=8/20us) per IEC 61000-4-5
- $\pm 30kV / \pm 20kV$ (air/contact)
- Constant clamping voltage across rate lpp range and temperature range
- DFN 1.6 x 1.6 x 0.55mm



TDS4001P



1 Line Transient Diverting Suppressor for 58V EOS Protection

- 58V, 1-line protection
- 20A I_{pp} (tp=8/20us) per IEC 61000-4-5
- $\pm 20kV / \pm 15kV$ (air/contact)
- Constant clamping voltage across rate lpp range and temperature range
- DFN 1.6 x 1.6 x 0.55mm



TDS5801P



SurgeSwitch Ordering Information

Part Number	Order Number	Reverse Standoff Voltage	Peak Pulse Current Rating	Breakdown Voltage (Min)	ESD Rating (Air/Contact)	Package Size	Qty per Reel	Reel Size
TDS2211P	TDS2211P.C	22V	40A (8x20μS)	25V	$\pm 30kV / \pm 30kV$	1.6 x 1.6 x 0.55mm	3000	7"
TDS3011P	TDS3011P.C	30V	35A (8x20μS)	34V	$\pm 30kV / \pm 30kV$	1.6 x 1.6 x 0.55mm	3000	7"
TDS3311P	TDS3311P.C	33V	35A (8x20μS)	36V	$\pm 30kV / \pm 30kV$	1.6 x 1.6 x 0.55mm	3000	7"
TDS4001P	TDS4001P.C	40V	24A (8x20μS)	46V	$\pm 30kV / \pm 20kV$	1.6 x 1.6 x 0.55mm	3000	7"
TDS4501P	TDS4501P.C	45V	24A (8x20μS)	46V	$\pm 30kV / \pm 20kV$	1.6 x 1.6 x 0.55mm	3000	7"
TDS5801P	TDS5801P.C	58V	20A (8x20μS)	68V	$\pm 20kV / \pm 15kV$	1.6 x 1.6 x 0.55mm	3000	7"

TVS Solutions

For more than 50 years, Semtech's Protection Products Group has been on the forefront of developing cutting-edge circuit protection solutions to safeguard the various circuit buses, ports, connectors, and interfaces found in consumer products and electronic systems. Semtech's proprietary TVS technologies lead the industry in protecting high-speed data circuits against

ESD, electromagnetic interference, cable discharge, lightning, and power surges. These innovative devices help ensure electronics do not fail in the presence of highly destructive overvoltage threats.

What Is ESD?

ESD is a natural phenomenon that occurs all-around us. ESD events occur when electrons—due to friction or induction—are redistributed on a material surface in such a way to create a charge imbalance and thus an electric field. When an electric field is sufficiently strong, the static charges seek equilibrium across the potential difference, and a violent electrical zap known as an electrostatic discharge can occur. These common electrical shocks occur with such frequency that most of the time they may not even be perceptible to humans, but they can mean disaster for microelectronic-based electronics. An ESD strike and resulting failure to the electronic product may lead to lost time to market, revenue and a loss of reputation in the market for a product supplier.

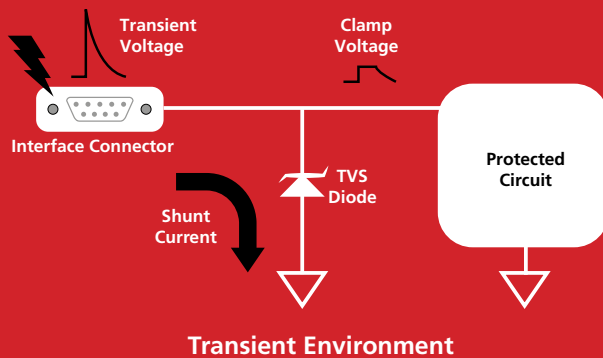

The Need For Robust ESD Protection

The world is more connected than ever. From smartphones to tablets to smart vehicles these devices give us constant access to real-time information and live communication. As our world becomes more connected, microelectronic chips are also becoming faster and more advanced. As this trend continues, the chips enabling these smaller, thinner and faster microelectronics must likewise scale to smaller geometries. As a result, these devices exhibit an increased sensitivity to real world ESD and transient voltage threats.

Increased device vulnerability to ESD threats, coupled with the trend in chip miniaturization, has compounded the challenge of designing adequate circuit-level ESD protection. With the increased ESD sensitivity of digital ICs, the need to protect systems with more robust off-chip/system-level TVS is more critical today than ever.

TVS Application Matrix

Semtech's protection products meet the industry's most rigid immunity standards, including:

- IEC 61000-4-2 (ESD)
- IEC 61000-4-4 (EFT)
- IEC 61000-4-5 (lightning)
- Telcordia GR-1089
- ITU K.20, K.21

Features

- Sub-5V solutions: 2.5V – 3.3V
- Ultra-low capacitance devices: <0.5pF
- Extremely low clamping voltage
- ESD protection with EMI/RFI filtering
- Single-line and multi-line protection
- Small package solutions, including Semtech's own leadless package
- High volume manufacturing
- RoHS/WEEE Compliant

Applications

- Portable electronics
- Ethernet
- Set top box
- HDTV/monitor interfaces
- Telecom/datacom interfaces
- Servers/desktop
- Notebooks/tablets
- Automotive interfaces (AEC-Q100 qualified)
- Wearables
- Internet of Things (IoT) nodes



TVS Solutions

Semtech has a rich and diverse portfolio of TVS protection devices. It is helpful to think of these devices as categorized into five basic subgroups:

μClamp® Family (MicroClamp®)

- General purpose ESD protection
- Single-line and multi-line devices
- Used in broad markets, but more commonly in portable and handheld applications

RClamp® Family (RailClamp®)

- Low capacitance ESD and transient voltage protection
- Protection for high-speed lines
- Surge and ESD level protection
- Multi-market adoption: used in high-speed data lines

PClamp® Family (PowerClamp™)

- Higher surge immunity for VBUS and DC lines
- High-surge protection (>100A 8x20μs surge events)
- Generally intended for VBUS and DC line applications

TClamp® Family (TransClamp®)

- High-surge, low capacitance protection
- Single-line and multi-line devices
- Targeted at telecom and some industrial applications

EClamp® Family (EMIClamp®)

- ESD protection in combination with filter devices
- TVS with integrated passive components, used for EMI filtering applications
- EClamp family also features TVS and termination passives for data interfaces

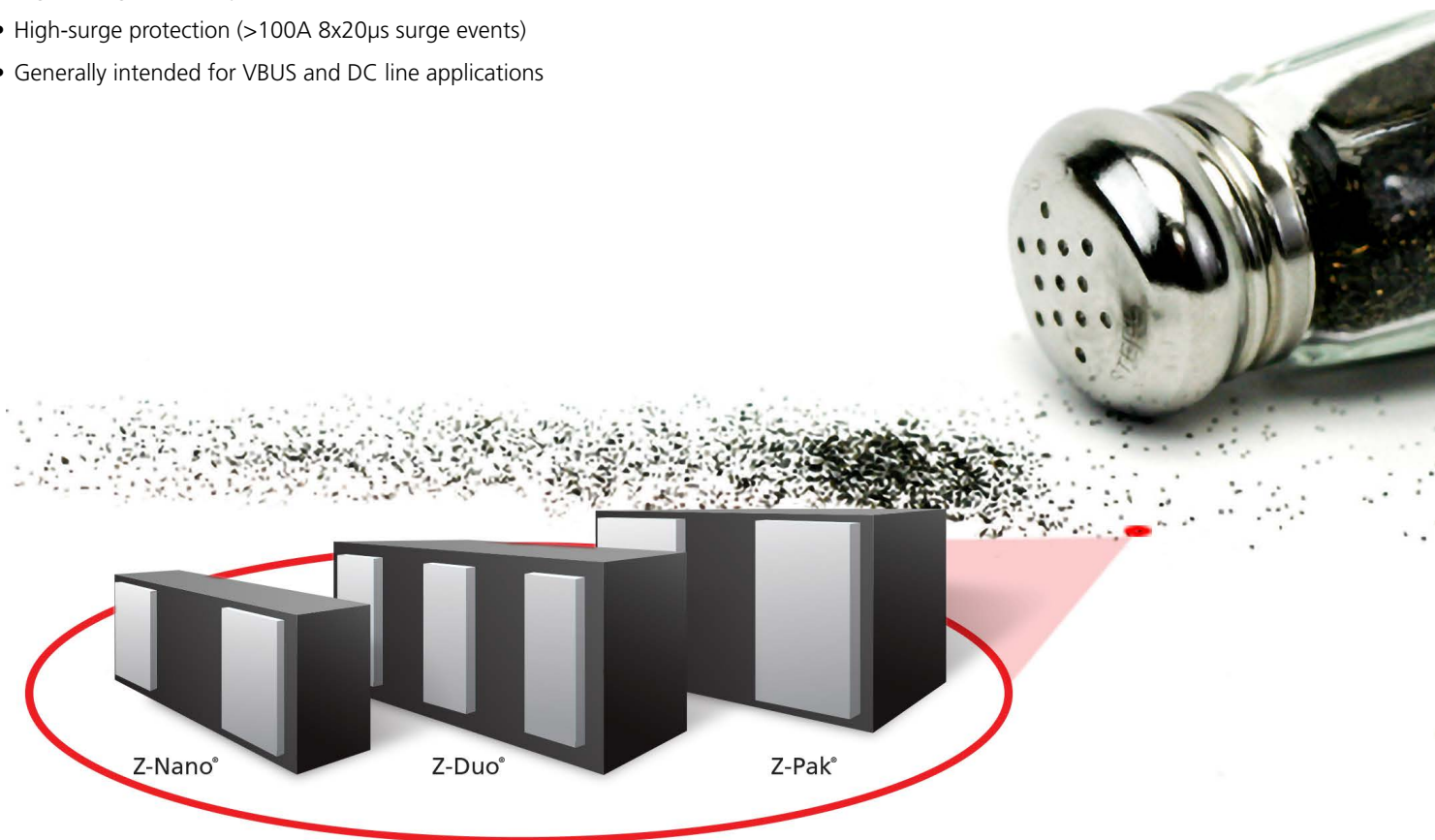

Part Number	T-Carrier xDSL	Antenna	Automotive (AEC-Q100) 10/100/1000 Ethernet	Industrial Sensing	Serial/Parallel Ports	LVDS	USB1.1/2.0/3.0/OTG	Multimedia Memory Port	Audio	Color LCD Display	VBUS/DC line	Keypad	HDMI/DisplayPort	Analog Video
EMIClamp® – ESD + EMI Protection Devices														
EClamp2374KQ			■							■				
EClamp2374K										■				
EClamp2376K										■				
EClamp2378K										■				
EClamp2384K										■				
EClamp2386K										■				
EClamp2388K										■				
EClamp2394P										■				
EClamp2396P										■				
EClamp2398P										■				
EClamp2410P								■						
EClamp2422N									■					
EClamp2454P										■				
EClamp2456P										■				
EClamp2458P										■				
EClamp2455K								■						
EClamp2455P								■						
EClamp2465T								■						
EClamp2515K								■						
EClamp2522P							■							
STF203-15								■						
STF203-22								■						
STF203-33								■						
TransClamp® – High-Power Surge TVS														
TClamp0602N	■	■		■										
TClamp1202P					■									
TClamp1272S		■												
TClamp2472S		■												
TClamp2482S		■												
TClamp2502N				■										■
TClamp2512N				■										
TClamp3302N		■		■										■
TClamp3312N				■										
LC01-6	■													
LC03-3.3	■			■										
LC03-6	■	■		■										
LC04-6	■	■												
LC05-6	■													
LC04-12	■	■												
RailClamp® – Low Capacitance TVS														
RClamp0502A				■		■	■							■
RClamp0582BQ				■			■							■
RClamp0582N				■		■	■	■						■
RClamp0504FA				■		■	■	■						■
RClamp0504N	■	■		■	■	■	■	■						■

Part Number	T-Carrier xDSL	Antenna	Automotive (AEC-Q100) 10/100/1000 Ethernet	Industrial Sensing	Serial/Parallel Ports	LVDS	USB1.1/2.0/3.0/OTG	Multimedia Memory Port	Audio	Color LCD Display	VBUS/DC line	Keypad	HDMI/DisplayPort	Analog Video
RClamp0504PA			■			■	■	■				■	■	
RClamp0506T						■							■	
RClamp0592PWQ		■	■	■		■	■					■	■	
RClamp0521PA						■	■	■						
RClamp0521Z		■				■	■						■	
RClamp0524PA						■				■			■	
RClamp0524PQ						■				■			■	
RClamp0531TQ		■	■	■										
RClamp0532T				■				■					■	
RClamp0534N				■				■						
RClamp0542T						■							■	
RClamp0544T						■							■	
RClamp0551P						■	■						■	
RClamp0552T						■	■							
RClamp0554S	■			■	■	■	■	■						■
RClamp3324T				■			■						■	
RClamp3354S				■			■							
RClamp0564P				■	■	■	■			■			■	■
RClamp7534P				■	■	■	■			■			■	■
RClamp0584J						■							■	
RClamp0821P						■	■	■					■	
RClamp0854P							■							
RClamp1255P							■							
RClamp1502B						■	■							
RClamp1521P						■	■	■					■	
RClamp1654P							■							
RClamp1851ZA				■										
RClamp2402B						■	■							
RClamp2451ZA				■										
RClamp2502L	■			■										
RClamp2504N				■		■	■	■						■
RClamp2504P				■		■	■	■						■
RClamp2574N				■		■	■							
RClamp2574NQ				■	■	■	■							
RClamp3374N				■	■	■	■							
RClamp3304NA	■			■		■	■	■						■
RClamp3304P				■		■	■	■						■
RClamp3321P							■							
RClamp3324P				■	■	■	■	■						
RClamp3328P				■		■	■	■					■	
RClamp3331ZA						■	■							
RClamp3346P				■		■	■	■						

Part Number	T-Carrier	xDSL	Antenna	Automotive (AEC-Q100)	10/100/1000 Ethernet	Industrial Sensing	Serial/Parallel Ports	LVDS	USB1.1/2.0/3.0/OTG	Multimedia Memory Port	Audio	Color LCD Display	VBUS/DC line	Keypad	HDMI/DisplayPort	Analog Video
RClamp3552T				■				■	■							
RClamp3624T									■							
RClamp3654PA									■							
RClamp7522T									■						■	
RClamp7524T									■						■	
RClamp7528T								■	■	■		■			■	
RClamp7538P								■	■	■		■			■	
RClamp0821ZA			■												■	
RClamp5031ZA			■						■	■						
RClamp3521ZA								■	■							
RClamp0551PQ			■	■					■						■	
RClamp0561PQ			■	■					■						■	
RClamp1561PQ			■													
RClamp3351ZA								■	■	■						
RClamp3371ZC					■				■						■	
RClamp3391ZC																
RClamp3331PQ			■	■					■	■						
RClamp0582NQ				■											■	■
RClamp0521ZA			■						■						■	
SR05		■					■		■							■
SR12		■														
SR2.8																■
SR3.3									■							■
SR70	■	■														■
SRDA05-4	■								■							■
SRDA12-4		■														
SRDA3.3-4	■								■							■
SRV05-4	■				■		■	■	■							■
MicroClamp® – TVS Arrays																
μClamp0301PQ			■													■
μClamp0501H							■					■	■			
μClamp0501P							■					■	■			
μClamp0501T							■					■	■			
μClamp0502P											■	■	■			
μClamp0502T							■					■	■			
μClamp0561P													■			
μClamp1061P																
μClamp1261P																
μClamp1561P																
μClamp2461P													■			
μClamp3061P																
μClamp3661P																
μClamp4061P																
μClamp6061P																
μClamp0504T													■	■		
μClamp0505T													■	■		
μClamp0506T																

Part Number	T-Carrier	xDSL	Antenna	Automotive (AEC-Q100)	10/100/1000 Ethernet	Industrial Sensing	Serial/Parallel Ports	LVDS	USB1.1/2.0/3.0/OTG	Multimedia Memory Port	Audio	Color LCD Display	VBUS/DC line	Keypad	HDMI/DisplayPort	Analog Video
μClamp0508T								■			■				■	
μClamp0504A								■							■	
μClamp0505A								■			■				■	
μClamp0511P														■	■	
μClamp0511T										■		■	■	■		
μClamp0524P									■						■	
μClamp0541Z											■		■	■		
μClamp1201H															■	
μClamp1201P								■							■	
μClamp1211P															■	■
μClamp1211T											■		■	■		
μClamp1211Z															■	■
μClamp2401T								■							■	■
μClamp2501T											■				■	
μClamp2511T															■	
μClamp2501ZA															■	
μClamp2804L								■								
μClamp3301P															■	■
μClamp3304A															■	■
μClamp3305P															■	■
μClamp3306P															■	■
μClamp3311P															■	■
μClamp3311PQ															■	■
μClamp3311T															■	■
μClamp3321ZA															■	■
μClamp3324P															■	■
μClamp3381P										■						
μClamp3603T										■					■	
μClamp5011ZA															■	■
SM712															■	
LCDA/SLVU Families – TVS Arrays																
LCDA12C-1																
LCDA15C-1																
LCDA24C-1																
SLVU2.8Q																■
SLVU2.8-4																
SLVU2.8-8																
PowerClamp™ High-surge TVS Diode																
PClamp0501P											■				■	
PClamp0801P															■	■
PClamp1011P											■				■	
PClamp1021P											■				■	
PClamp1211P											■					
PClamp1221P											■				■	
PClamp2011P											■				■	



EMIClamp® – ESD + EMI Protection Devices

Part Number	Description	Device Schematic	V _{RWM} Max (V)	V _{BR} Min (V)	C (pF) @ V _R = 0V	C (pF) @ V _R = 2.5V	R (ohm)	L (nH)	C Max (pF) L-G @ V _R = 0V	I _s Max (μA) @ V _{RWM}	Package	Size (mm)
EClamp2374K EClamp2376K EClamp2378K	4, 6, 8-line ESD/EMI protection for color LCD interfaces		5	6	10	–	100	–	24	–	SLP1713P8 SLP2513P12 SLP3313P16	1.7 x 1.3 x 0.5 2.5 x 1.3 x 0.5 3.3 x 1.3 x 0.5
EClamp2384K EClamp2386K EClamp2388K	4, 6, 8-line ESD/EMI protection for color LCD interfaces, 400μm lead pitch		5	6	–	12	200	–	–	–	SLP1713P8 SLP2513P12 SLP3313P16	1.7 x 1.3 x 0.5 2.5 x 1.3 x 0.5 3.3 x 1.3 x 0.5
EClamp2394P EClamp2396P EClamp2398P	4, 6, 8-line ESD/EMI protection for color LCD interfaces		5	6	–	12	–	19	–	–	SLP2116P8 SLP3016P12 SLP4016P16	2.1 x 1.6 x 0.58 3.0 x 1.6 x 0.58 4.0 x 1.6 x 0.58
EClamp2374KQ	4-line ESD/EMI TVS for color LCD display		5	6	20	–	100	n/a	24	0.50	SLP1713P	1.7 x 1.3 x 0.5
EClamp2422N	2 line ESD/EMI protection for audio interfaces		5	6	100	–	–	2	–	–	SLP1510N6	1.45 x 1.0 x 0.58
EClamp2454P EClamp2456P EClamp2458P	4, 6, 8-line ESD/EMI protection for color LCD interfaces		5	6	–	12	–	28	–	–	SLP2116P8 SLP3016P12 SLP4016P16	2.1 x 1.6 x 0.58 3.0 x 1.6 x 0.58 4.0 x 1.6 x 0.58
EClamp2455K EClamp2455P	4-line ESD/EMI protection for SIM cards, ('K'=400μm lead pitch) ('P'=500μm lead pitch)		5	6	20	–	100 47	–	24	0.5	SLP1713P8 SLP2116P8	1.7 x 1.3 x 0.5 2.1 x 1.6 x 0.58
EClamp2465T	4-line ESD/EMI protection for SIM card		5	6	10	–	100	–	12	0.5	SLP1713P8T	1.7 x 1.3 x 0.4
EClamp2515K	ESD protection for T-Flash/MicroSD interfaces		5	6	22	–	45	–	–	–	SLP3313P16	3.3 x 1.3 x 0.5
EClamp2522P	USB upstream port filter & TVS for EMI filtering and ESD protection		5.5	6	20	–	22	–	45	1	SLP1616P6	1.6 x 1.6 x 0.58
STF203-15 STF203-22 STF203-33	USB upstream port filter & TVS for EMI filtering and ESD protection		5.25	6	47	–	15 22 33	–	–	5	SC-70 6L	2.1 x 2.1 x 1.1 2.1 x 2.1 x 1.1 2.1 x 2.1 x 1.1

TransClamp® – High-Power Surge TVS

Part Number	Description	Device Schematic	V _{RWM} Max (V)	V _{SR} Min (V)	C _J Max (pF) L-L @ V _R = 0V	Peak Power (W) (8/20µs)	Peak Power (W) (10/1000µs)	I _{PP} (A) @ (10/1000µs)	I _{PP} (A) @ (8/20µs)	I _R Max (µA) @ V _{RWM}	Package	Size (mm)
TClamp0602N TClamp2502N TClamp3302N	2-line, low cap TVS for Ethernet and telecom interfaces		6 2.5 3.3	6.8 – –	12	2,500 – –	–	–	95	5 0.5 1	SLP2626P10	2.6 x 2.6 x 0.6 2.6 x 2.6 x 0.6 2.6 x 2.6 x 0.6
TClamp1202P	Low cap TVS for RS-485 interfaces		12	13.3	12	–	300	12	100	0.1	SLP2020P5	2.0 x 2.0 x 0.6
TClamp1272S	Low cap TVS for xDSL interfaces		12	13.5	5	600	–	–	20	0.1	SOT-23 6L	3.1 x 2.8 x 1.45
TClamp2512N TClamp3312N	2-line, low cap TVS for Ethernet and telecom interfaces		2.5V 3.3V	2.7V 3.5V	8	–	–	–	120	0.1	SLP2626P10	2.6 x 2.6 x 0.6 2.6 x 2.6 x 0.6
TClamp2472S	Low cap TVS for xDSL interfaces		24	27	2	–	–	–	–	0.1	SOT-23 6L	3.1 x 2.8 x 1.45
TClamp2482S	Low cap TVS for xDSL interfaces		24	27	2	150	–	–	20	0.1	SOT-23 6L	3.1 x 2.8 x 1.45
LC01-6	Low cap TVS for high-speed telecommunication systems		6	8	–	–	1,500	100	–	25	SO-16W	10.3 x 10.3 x 2.65
LC03-3.3	2-line, low cap 3.3V TVS for high-speed interfaces		3.3	–	12	1,800	–	–	100	1	SO-8	5.0 x 6.0 x 1.75
LC03-6	2-line, low cap TVS for high-speed data interfaces		6	6.8	12	2,000	–	–	100	25	SO-8	5.0 x 6.0 x 1.75
LC04-6 LC05-6	Dual, low cap TVS array for telecom linecard applications, protects 2 tip and ring line pairs		6	6.8	15	– 2,000	1,000 –	70 –	200 100	15	SO-16	10.0 x 6.0 x 1.75 10.0 x 6.0 x 1.75
LC04-12	Dual, low cap TVS array for telecom linecard applications, protects 2 tip and ring line pairs		12	13.3	15	600	600	25	100	2	SO-16	10.0 x 6.0 x 1.75

RailClamp® – Low Capacitance TVS

Part Number	Description	Device Schematic	V _{RWM} Max (V)	V _{BR} Min (V)	C _i Max (pF) L-L @ V _s = 0V	Peak Power (W) (8/20μs)	I _{PP} (A) @ (8/20μs)	I _r Max (μA) @ V _{RWM}	Package	Size (mm)
RClamp0502A	2-line, ultra-low cap TVS array		5	6	0.7	50	3	1	SC-89	1.7 x 1.7 x 0.6
RClamp0502BA RClamp1502B RClamp2402B	2-line protection, ultra-low cap TVS for ESD/CDE protection		5 15 24	6 16.7 26.7	0.9	125 200 200	5 5 4	1	SC-75	1.7 x 1.75 x 0.9 1.7 x 1.75 x 0.9 1.7 x 1.75 x 0.9
RClamp2451ZA	24V, 1-line ESD protection		24	25.5	0.45	60	3	0.05	SLP0603P2X3	0.6 x 0.3 x 0.25
RClamp0504FA RClamp0504S RClamp0504N	4-line protection, low cap TVS array		5	6	1.5 1.5 5*	150 150 300	6 6 12	3 3 5	SC-70 6L SOT-23 6L SLP2020P6	2.1 x 2.1 x 1.1 3.1 x 2.8 x 1.45 2.0 x 2.0 x 0.6
RClamp0504PA	4-line protection, low cap TVS array		5	6	1	150	6	3	SLP1616P6	1.6 x 1.6 x 0.58
RClamp0506T	6-line protection, ultra-low cap TVS for high-speed applications		5	6.5	0.4	75	5	0.1	SLP3313P6T	3.3 x 1.3 x 0.4
 RClamp0592PWQ	5V, 2-line surge and ESD protection for high-speed applications		5	6.5	1.2	60	10	0.1	DFN1006N3T	1.0 x 0.6 x 0.55
RClamp0521PA RClamp0821P RClamp1521P	Ultra-low cap, 1-line ESD protection		5 8 15	6 10 16.7	0.5	100 100 120	4	1	SLP1006P2	1.0 x 0.6 x 0.5 1.0 x 0.6 x 0.5 1.0 x 0.6 x 0.5
RClamp0521Z	Ultra small, 1-line ESD protection		5	6	0.5	100	4	0.1	SLP0603P2X3A	0.6 x 0.3 x 0.25
RClamp3552T	2-line, low voltage, ESD protection		3.5	-	0.4	60	4	0.3	SLP0603P2X3	0.6 x 0.3 x 0.25
RClamp0522P	Protect 2 lines for high-speed applications		5	6	0.4	150	5	1	SLP1610P4	1.6 x 1.0 x 0.58
 RClamp0524PQ RClamp0524PA	Protect 4 lines for high-speed applications		5	6 6.5	0.4	150 75	5	1 0.1	SLP2510P8	2.5 x 1.0 x 0.58 2.5 x 1.0 x 0.58
 RClamp0531TQ	1-line protection, ultra-low cap TVS for automotive applications		5	6	0.8	80	4	0.1	SLP1006P2T	1.0 x 0.6 x 0.4

* Line-to-ground capacitance (max) value

RailClamp® – Low Capacitance TVS (Continued)

Part Number	Description	Device Schematic	V _{RWM} Max (V)	V _{BR} Min (V)	C _i Max (pF) L-L @ V _R = 0V	Peak Power (W) (8/20μs)	I _{PP} (A) @ (8/20μs)	I _R Max (μA) @ V _{RWM}	Package	Size (mm)
RClamp0534N	4-line protection, low cap TVS for high-speed applications		5	6	3	500	25	0.5	SLP3020N10	3.0 x 2.0 x 0.6
RClamp0542T	Protect 2 lines for high-speed applications		5	6.5	0.4	75	5	0.05	SLP1610P4T	1.6 x 1.0 x 0.4
RClamp0544T	Protect 4 lines for high-speed applications		5	6.5	0.4	75	5	0.1	SLP2010P8T	2.0 x 1.0 x 0.4
RClamp0551P	Ultra-low cap, 1-line ESD protection		5	6	0.5	60	3	0.1	SLP1006P2	1.0 x 0.6 x 0.5
RClamp0552T	Ultra-low cap, 2-line ESD protection		5	6.5	0.4	60	3	0.02	SLP1006N3T	1.0 x 0.6 x 0.4
RClamp0564P	4-line, low-capacitance protection for high-speed interfaces		5	6.5	0.20	-	3	50	SGP2010N5	2.0 x 1.0 x 0.5
RClamp7534P	4-line, low-capacitance protection for high-speed interfaces		5	6.5	0.22	-	4	100	SGP2010N5	2.0 x 1.0 x 0.5
RClamp0554S	4 line protection, low cap TVS for high-surge applications		5	6	5*	375	25	0.5	SOT-23 6L	3.1 x 2.8 x 1.45
RClamp0582B	2-line protection, ultra-low cap TVS for high-speed applications		5	6	0.8	300	15	0.1	SC-75	1.7 x 1.75 x 0.9
 RClamp0582BQ	2 line protection, ultra-low cap TVS for automotive applications		5	6	0.8	300	15	0.1	SC-75	1.7 x 1.75 x 0.9
RClamp0582N	2 data, 1 power line protection, ultra-low cap TVS for automotive applications		6.5	7	0.5	125	5	0.1	SLP1210N6	1.2 x 1.0 x 0.58
RClamp0584J	4-line protection, ultra-low cap for high-speed applications		5	6.5	0.4	75	5	0.1	SLP2710P8	2.7 x 1.0 x 0.5

* Line-to-ground capacitance (max) value

RailClamp® – Low Capacitance TVS (Continued)

Part Number	Description	Device Schematic	V _{RWM} Max (V)	V _{BR} Min (V)	C _i Max (pF) L-L @ V _R = 0V	Peak Power (W) (8/20µs)	I _{PP} (A) @ (8/20µs)	I _R Max (µA) @ V _{RWM}	Package	Size (mm)
RClamp0854P	3 data line protection and 1 power line for USB charger and USB OTG		5.5	6.5	0.5	100	3	1	SLP1616P6	1.6 x 1.6 x 0.58
RClamp1654P	3 data line protection and 1 power line for USB charger and USB OTG		5.5	6.5	0.5	100	3	1	SLP1616P6	1.6 x 1.6 x 0.58
RClamp2502L	2.5V, flow-through TVS for gigabit and fast Ethernet protection		2.5	-	5	800	40	1	SO-8	5.0 x 6.0 x 1.75
RClamp2504N RClamp3304NA	4-line protection, low cap TVS array for Ethernet and telecom interfaces		2.5 3.3	-	5*	450	25	5	SLP2626P10	2.6 x 2.6 x 0.6 2.6 x 2.6 x 0.6
RClamp2504P RClamp3304P	4-line ultra-low cap TVS array		2.5 3.3	-	0.8*	80	5	0.5	SLP1616P6	1.6 x 1.6 x 0.58 1.6 x 1.6 x 0.58
 RClamp2574NQ RClamp3374N	4-line protection, high power TVS for Ethernet interfaces		2.5 3.3	-	5*	1,000	40	0.5	SLP3020N10	3.0 x 2.0 x 0.6 3.0 x 2.0 x 0.6
RClamp3321P	3.3V, 1-line ESD protection		3.3	5.5	0.35	25	3	0.05	SLP1006P2	1.0 x 0.6 x 0.5
RClamp3324P	3.3V, 4-line surge and ESD protection		3.3	-	0.4	-	4.5	0.05	SGP2510P8	2.5 x 1.0 x 0.6
RClamp3328P	3.3V, 8-line surge and ESD protection		3.3	-	0.4	75	5	0.1	SGP3810N9	3.8 x 1.0 x 0.5
RClamp3331ZA	3.3V, 1-line ESD protection		3.3	5.5	0.45	30	4	0.05	SLP0603P2X3	0.6 x 0.3 x 0.25
RClamp3346P	3.3V, 6-line ESD protection for high-speed applications		3.3	-	0.4	-	4.5	0.05	SGP2708N7	2.7 x 0.8 x 0.5

* Line-to-ground capacitance (max) value

RailClamp® – Low Capacitance TVS (Continued)

Part Number	Description	Device Schematic	V _{RWM} Max (V)	V _{BR} Min (V)	C _J Max (pF) L-L @ V _R = 0V	Peak Power (W) (8/20μs)	I _{PP} (A) @ (8/20μs)	I _R Max (μA) @ V _{RWM}	Package	Size (mm)
RClamp3324T	3.3V, flow-through TVS for USB 3.0 interfaces		3.3	–	0.4	75	5	0.1	SLP1710P4T	1.7 x 1.0 x 0.4
RClamp3354S	4-line, 3.3V TVS for GbE interfaces		3.3	–	5*	400	25	0.5	SOT-23	3.1 x 2.8 x 1.45
RClamp3654PA	3 data line protection and 1 power line for USB charger and USB OTG		5.5	6.5	0.5	100	3	1	SLP1616P6	1.6 x 1.6 x 0.58
RClamp7522T	2-line protection, ultra-low cap TVS for high-speed applications		5	6.5	0.4	100	4	0.1	SLP1007N5T	1.0 x 0.7 x 0.4
RClamp7524T	4-line protection, ultra-low cap TVS for high-speed applications		5	6.5	0.4	75	5	0.1	SLP1308N5T	1.3 x 0.8 x 0.4
RClamp7528T RClamp7538P	8-line protection, ultra-low cap TVS for high-speed applications		5	6.5	0.4	75	5	0.1	SLP2611N9T SLP3810N9	2.6 x 1.1 x 0.4 3.8 x 1.0 x 0.5
SR05 SR12	2-line, low cap TVS diode array		5 12	6 13.3	10*	500 550	25 16	5 1	SOT-143	3.04 x 2.64 x 1.22 3.04 x 2.64 x 1.22
SR2.8 SR3.3	2-line, low cap TVS diode array		2.8 3.3	–	10*	200 150	14 10	1 1	SOT-143	3.04 x 2.64 x 1.22 3.04 x 2.64 x 1.22
SR70	2-line, low cap TVS diode array		70	85	10*	–	24	5	SOT-143	3.04 x 2.64 x 1.22
SRDA3.3-4	4-line, low capacitance TVS diode array		3.3	–	15*	500	25	1	SO-8	5.0 x 6.0 x 1.75





* Line-to-ground capacitance (max) value

RailClamp® – Low Capacitance TVS (Continued)

Part Number	Description	Device Schematic	V _{RWM} Max (V)	V _{BR} Min (V)	C _i Max (pF) L-L @ V _R = 0V	Peak Power (W) (8/20μs)	I _{PP} (A) @ (8/20μs)	I _R Max (μA) @ V _{RWM}	Package	Size (mm)
SRDA5-4 SRDA12-4	4-line, low capacitance TVS diode array		5 12	6 13.3	15*	500	25 20	10 1	SO-8	5.0 x 6.0 x 1.75 5.0 x 6.0 x 1.75
SRV05-4	4-line, low capacitance TVS diode array		5	6	5*	300	12	5	SOT-23 6L	3.1 x 2.8 x 1.45
RClamp0821ZA RClamp5031ZA	Ultra small low capacitance 1 line ESD protection		8 5	10 6.5	0.5 0.45	–	4	0.1 0.05	SLP0603P2X3F	0.6 x 0.3 x 0.25 0.6 x 0.3 x 0.25
RClamp3521ZA	1-line, low cap 3.5V TVS for high-speed interfaces		3.5	5.5	0.55	30	6	0.05	SLP0603P2X3F	0.6 x 0.3 x 0.25
RClamp3351ZA RClamp3371ZC RClamp3391ZC	Ultra low cap TVS for high-speed interfaces		3.3	5.5	0.6 0.25 0.2	65 65 45	10 9 7	0.05	SLP0603P2X3F SLP0603P2X3J SLP0603P2X3J	0.6 x 0.3 x 0.25 0.6 x 0.3 x 0.25 0.6 x 0.3 x 0.25
RClamp0551PQ	Low capacitance 1 line protection of automotive interfaces		5	6	0.5	45	3	0.1	SLP1006P2	1.0 x 0.6 x 0.5
RClamp0561PQ RClamp1561PQ	Low capacitance 1 line protection of automotive interfaces		5.5 15	6.5 16.5	0.18 0.3	40 70	2	0.05	SLP1006P2	1.0 x 0.6 x 0.5 1.0 x 0.6 x 0.5
RClamp3331PQ	Low capacitance ESD and EOS protection		3.3	6	0.38	30	10	0.05	SLP1006P2	1.0 x 0.6 x 0.5
RClamp0582NQ	Low capacitance 2 line ESD and EOS protection		6.5	7	0.5	125	5	0.1	SLP1210N6	1.2 x 1.0 x 0.58
RClamp0521ZA	Ultra small, 1-line ESD protection		5	6.5	–	–	2	0.1	SLP0603P2X3	0.6 x 0.3 x 0.25

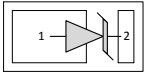
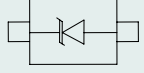
* Line-to-ground capacitance (max) value

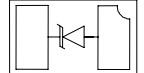
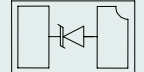
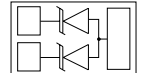
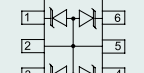
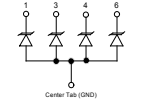
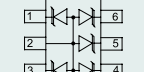
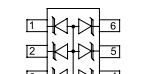
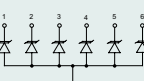
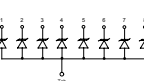
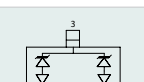

MicroClamp® - TVS Arrays

Part Number	Description	Device Schematic	V _{RWM} Max (V)	V _{BR} Min (V)	C _J Max (pF) L-G @ V _R = 0V	Peak Power (W) (8/20μs)	I _{PP} (A) @ (8/20μs)	I _R Max (μA) @ V _{RWM}	Package	Size (mm)
μClampxx61P	High power, 1-line ESD and surge protection		5-40	-	220 to 125	1,200 to 1,500	80-5	0.2	SLP1608P2	1.6 x 0.8 x 0.5
μClamp0501H μClamp1201H	1-line ESD protection		5 12	6 13.3	160 60	240 200	16 8	5 1	SOD-523	1.7 x 0.9 x 0.7 1.7 x 0.9 x 0.7
 μClamp0301PQ μClamp0501P μClamp1201P	1-line ESD protection		3 5 12	- 6 13.3	30 160 60	40 200 200	5 16 8	0.5 5 1	SLP1006P2	1.0 x 0.6 x 0.5 1.0 x 0.6 x 0.5 1.0 x 0.6 x 0.5
μClamp0501T μClamp2401T	1-line ESD protection		5 24	6 27	10 50	25 150	2 3	0.25	SLP1006P2T	1.0 x 0.6 x 0.4 1.0 x 0.6 x 0.4
μClamp0502P μClamp0502T	2-line ESD protection		5	6	10	25	2	0.25	SLP1006P3 SLP1006P3T	1.0 x 0.6 x 0.5 1.0 x 0.6 x 0.5
μClamp0504A μClamp3304A	4-line ESD protection array		5 3.3	6 -	75 30	100 40	7 5	1 0.5	SC-89	1.7 x 1.7 x 0.6 1.7 x 1.7 x 0.6
μClamp0504T μClamp0505T μClamp0506T	4, 5, 6-line ESD protection		5	6	10	25	2	0.25	SLP1313P6T	1.3 x 1.3 x 0.4 1.3 x 1.3 x 0.4 1.3 x 1.3 x 0.4
μClamp0505A	5-line ESD protection array		5	6	75	100	7	1	SC-89	1.7 x 1.7 x 0.6
μClamp0506A	5-line ESD protection array		5	6	40	100	7	1	SC-89	1.7 x 1.7 x 0.6
μClamp0506P	6-line ESD protection array		5	6	75	100	7	1	SLP1616P6	1.6 x 1.6 x 0.58
μClamp0508T	8-line ESD protection		5	6	10	25	2	0.25	SLP1713P8T	1.7 x 1.3 x 0.4
SM712	300W asymmetrical 2-line 7V/12V protection in SOT23-3		7,12	7.5 13.3	75	550-700	21	0.2	JEDEC SOT-23	3.04 x 2.64 x 1.2
μClamp2501ZA	1 line 2.5V TVS diode		2.5	3	4.5	65	8	0.05	SLP0603P2X3F	0.6 x 0.3 x 0.25

MicroClamp® - TVS Arrays (Continued)

Part Number	Description	Device Schematic	V _{RWM} Max (V)	V _{BR} Min (V)	C _i Max (pF) L-G @ V _R = 0V	Peak Power (W) (8/20µs)	I _{PP} (A) @ (8/20µs)	I _s Max (µA) @ V _{RWM}	Package	Size (mm)
µClamp0511P µClamp1211P µClamp3311P	1-line ESD protection		5 12 3.3	6 13.3 -	75 25 15	170 200 90	12 7 5	1 1 0.5	SLP1006P2	1.0 x 0.6 x 0.5 1.0 x 0.6 x 0.5 1.0 x 0.6 x 0.5
µClamp0511T	1-line ESD protection		5	6	7	-	2	0.05 (V _R =3.3V)	SLP1006P2T	1.0 x 0.6 x 0.4
µClamp0541Z µClamp1211Z	Ultra small, 1 line ESD protection		5 12	6 14.2	9 25	25 175	2 7	0.05	SLP0603P2X3	0.6 x 0.3 x 0.25 0.6 x 0.3 x 0.25
µClamp0524P µClamp3324P	4-line, low voltage TVS for ESD protection		5 3.3	6 -	160 30	240 40	16 5	5 0.5	SLP2116P8	2.1 x 1.6 x 0.58 2.1 x 1.6 x 0.58
µClamp2501T	1-line, 2.5V TVS for ESD protection		2.5	-	30	40	5	0.05	SLP1006P2T	1.0 x 0.6 x 0.4
µClamp2511T µClamp3311T µClamp1211T	1-line ESD protection		2.5 3.3 12	- - 13.3	10 7 7	40 40 -	5 5 -	0.05	SLP1006P2T	1.0 x 0.6 x 0.4 1.0 x 0.6 x 0.4 1.0 x 0.6 x 0.4
µClamp3321ZA	1-Line ESD protection		3.3 5	5.5 6.5	0.45 5	30	4 2.5	0.05 0.02	SLP0603P2X3	0.6 x 0.3 x 0.25
µClamp2804L	4-line, 2.8V TVS array for Ethernet applications		2.8	-	-	100	10	0.05	SO-8	5.0 x 6.0 x 1.75
µClamp3301P	1-line, low voltage ESD/CDE protection		3.3	-	30	40	5	0.5	SLP1006P2	1.0 x 0.6 x 0.5
µClamp3305P	5-line, 3.3V TVS		3.3	-	25	40	5	0.5	SLP1616P6	1.6 x 1.6 x 0.58
µClamp3306P	6-line, 3.3V TVS		3.3	-	25	40	5	0.5	SLP1616P6	1.6 x 1.6 x 0.58
 µClamp3311PQ	1-line, low voltage TVS for automotive applications		3.3	-	15	90	5	0.5	SLP1006P2	1.0 x 0.6 x 0.5
µClamp3381P	3.3V, 1-line ESD and surge protection		3.3	4.5	35	275	25	0.1	SGP1006N2	1.0 x 0.6 x 0.5
µClamp5011ZA	1-line ESD protection		5	6.5	5	30	2.5	0.02	SLP0603P2X3	0.6 x 0.3 x 0.25
µClamp3612P	1-line, 33V TVS for proximity switch input protection		33	36	25	170	-	1	SLP1006P2	1.0 x 0.6 x 0.5
µClamp3603T	3-line, 36V TVS for proximity switch protection		36	-	50	-	-	1	SLP1710N6T	1.7 x 1.0 x 0.4

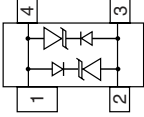
LCDA/SLVU Families - TVS Arrays

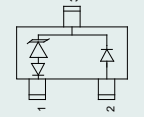
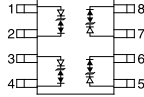
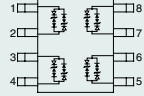
Part Number	Description	Device Schematic	V _{RWM} Max (V)	V _{BR} Min (V)	C _J Max (pF) L-G @ V _R = 0V	Peak Power (W) (8/20μs)	I _{PP} (A) @ (8/20μs)	I _R Max (μA) @ V _{RWM}	Package	Size (mm)
LCDA12C-1 LCDA15C-1 LCDA24C-1	1-line, low cap TVS diode array		12 15 24	13.3 16.7 26.7	15 15 10	500	–	5 5 1	SOT-143	3.04 x 2.64 x 1.22 3.04 x 2.64 x 1.22 3.04 x 2.64 x 1.22
 SLVU2.8Q	1-line, 2.8V TVS for automotive applications		2.8	–	100	400	24	0.25	SOT-23	3.1 x 2.8 x 1.45
SLVU2.8-4	4-line, EPD TVS diode array for ESD and latch-up protection		2.8	–	–	400	24	1	SO-8	5.0 x 6.0 x 1.75
SLVU2.8-8	8-line EPD TVS diode array for ESD and latch-up protection		2.8	–	–	600	30	1	SO-8	5.0 x 6.0 x 1.75

PowerClamp™ High-surge TVS Diode

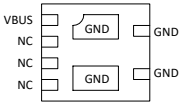
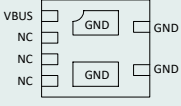
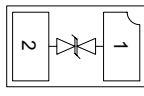
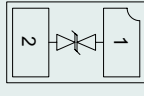
Part Number	Description	Device Schematic	V _{RWM} Max (V)	V _{BR} Min (V)	C _J Max (pF) L-G @ V _R = 0V	Peak Power (W) (8/20μs)	I _{PP} (A) @ (8/20μs)	I _R Max (μA) @ V _{RWM}	Package	Size (mm)
PClamp1211P	Power MicroClamp 1-line high-surge TVS diode		13.5	14.5	2,500	5,000	180	0.35	SLP2018P6	2.0 x 1.8 x 0.57
PClamp1011P PClamp2011P	Power MicroClamp 1-line high-surge TVS diode		10 23	12.5 27	2,500 800	4,700 5,700	180 120	0.15	SLP2018P6	2.0 x 1.8 x 0.57 2.0 x 1.8 x 0.57
PClamp0501P PClamp1021P PClamp1221P	1-line surge protection		5 10 12	5 11 13	1,150 600 430	1,800 1,680 2,000	80	0.1	SGP1610N2-D	1.6 x 1.0 x 0.53 1.6 x 1.0 x 0.53 1.6 x 1.0 x 0.53
PClamp0801P	Power MicroClamp 1 line high-surge TVS diode		7.6	7.96	1,150	500	50	5	SGP1610N2-D	1.6 x 1.0 x 0.53

Key Applications

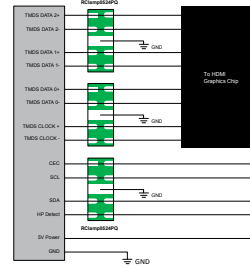
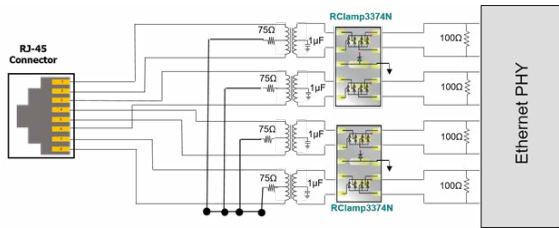

Ethernet

Part Number	V _{RWM} (V)	Lines	ESD Rating (Air/Contact)	Surge (8x20us) (A)	Cap (pF)	Size (mm)
RClamp3374N	3.3	4	±30kV/±30kV	40	5	3.0 x 2.0 x 0.6
RClamp3354S	3.3	4	±30kV/±30kV	25	5	3.1 x 2.8 x 1.45
RClamp0592PWQ	5.0	2	±30kV/±30kV	10	1	1.0 x 0.6 x 0.55
RClamp0582BQ	5.0	2	±30kV/±25kV	15	1.2	1.6 x 1.6 x 0.75

HDMI

Part Number	V _{RWM} (V)	Lines	ESD Rating (Air/Contact)	Surge (8x20us) (A)	Cap (pF)	Size (mm)
RClamp0574P	5.5	4	±15kV/±10kV	5	0.3	2.0 x 1.0 x 0.5
RClamp0524PQ	5.0	4	±25kV/±15kV	5	1.5	2.5 x 1.0 x 0.58
RClamp0564P	5.0	4	±15kV/±10kV	3	0.2	2.0 x 1.0 x 0.5
RClamp0524PA	5.0	4	±17kV/±12kV	5	0.8	2.5 x 1.0 x 0.58
RClamp7524T	5.0	4	±30kV/±25kV	5	0.6	1.3 x 0.8 x 0.4
RClamp7534P	5.0	4	±25kV/±20kV	4	0.22	2.0 x 1.0 x 0.5

Pins A1 – A12

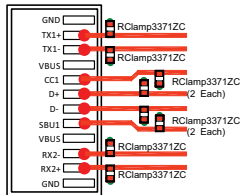

Pins B1 – B12

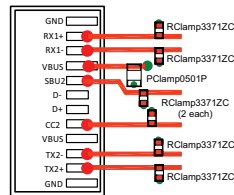

USB Type-C

Part Number	V _{RWM} (V)	Lines	ESD Rating (Air/Contact)	Surge (8x20us) (A)	Cap (pF)	Size (mm)
RClamp0592PWQ	5.0	2	±30kV/±30kV	10	1	1.0 x 0.6 x 0.55
RClamp33712C	3.3	1	±17kV/±10kV	9	0.25	0.6 x 0.3 x 0.25
μClamp5011ZA	5.0	1	±18kV/±15kV	2.5	5	0.6 x 0.3 x 0.25
μClamp2271P	22	1	±30kV/±30kV	25	165	1.6 x 1.0 x 0.57

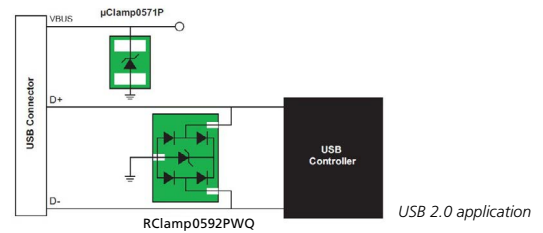

USB 2.0

Part Number	V _{RWM} (V)	Lines	ESD Rating (Air/Contact)	Surge (8x20us) (A)	Cap (pF)	Size (mm)
RClamp7522T	5.0	3	±25kV/±15kV	4	0.4	1.0 x 0.7 x 0.4
RClamp0582B	5.0	2	±30kV/±25kV	15	1.2	1.6 x 1.6 x 0.75
RClamp0592PWQ	5.0	2	±30kV/±30kV	10	1	1.0 x 0.6 x 0.55
μClamp0571P	5.0	1	±30kV/±30kV	80	675	1.6 x 1.0 x 0.57

Thunderbolt 3

Part Number	V _{RWM} (V)	Lines	ESD Rating (Air/Contact)	Surge (8x20us) (A)	Cap (pF)	Size (mm)
RClamp33912C	3.3	1	±15kV/±8kV	7	0.2	0.6 x 0.3 x 0.25
RClamp10112C	1.0	1	±15kV/±10kV	2.5	0.2	0.6 x 0.3 x 0.25

Audio Port/Side Keys Protection

Part Number	V _{RWM} (V)	Lines	ESD Rating (Air/Contact)	Surge (8x20us) (A)	Cap (pF)	Size (mm)
μClamp3321ZA	3.3	1	±17kV/±15kV	4	5	0.6 x 0.3 x 0.25
μClamp0541Z	5.0	1	±17kV/±17kV	2	9	0.6 x 0.3 x 0.25
μClamp5011ZA	5.0	1	±18kV/±15kV	2.5	5	0.6 x 0.3 x 0.25
μClamp1211Z	12	1	±30kV/±30kV	7	25	0.6 x 0.3 x 0.25

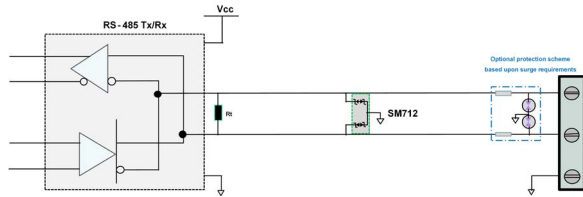

RS-485						
Part Number	V _{RWM} (V)	Lines	E SD Rating (Air/Contact)	Surge (8x20us) (A)	Cap (pF)	Size (mm)
SM712	12 (Pin 3 to 1 or 2) 7 (Pin 3 to 1 or 2)	2	±30kV/±30kV	21 (Pin 1 or 2 to 3) 38 (Pin 3 to 1 or 2)	75	3.04 x 2.64 x 1.2

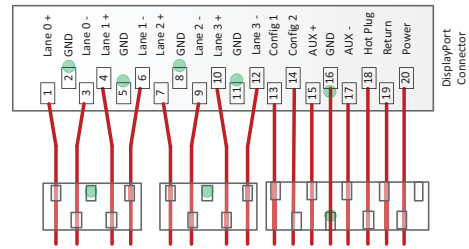

Display Port						
Part Number	V _{RWM} (V)	Lines	ESD Rating (Air/Contact)	Surge (8x20us) (A)	Cap (pF)	Size (mm)
RClamp0564P	V _{RWM} (V)	4	±15kV/±10kV	3	0.2	2.0 x 1.0 x 0.5
RClamp7534P	5.0	4	±25kV/±20kV	4	0.22	2.0 x 1.0 x 0.5
RClamp7538P	5.0	8	±25kV/±20kV	5	0.6	3.8 x 1.0 x 0.5

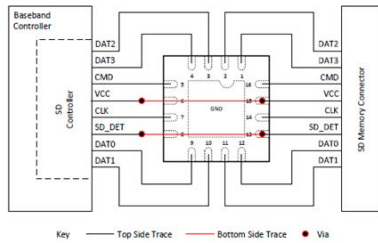

SD Card						
Part Number	V _{RWM} (V)	Lines	ESD Rating (Air/Contact)	Surge (8x20us) (A)	Cap (pF)	Size (mm)
RClamp3331ZA	3.3	1	±20kV/±18kV	4	0.45	0.6 x 0.3 x 0.25
RClamp3351ZA	3.3	1	±25kV/±22kV	10	0.6	0.6 x 0.3 x 0.25
PClamp0511ZV	5.0	1	±30kV/±30kV	115	275	1.0 x 0.6 x 0.25

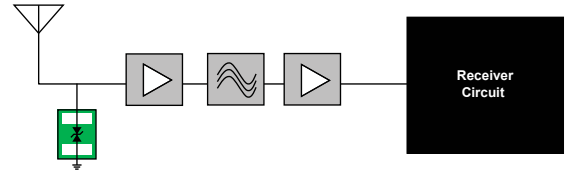

Antenna						
Part Number	V _{RWM} (V)	Lines	ESD Rating (Air/Contact)	Surge (8x20us) (A)	Cap (pF)	Size (mm)
RClamp3331PQ	3.3	1	±30kV/±30kV	10	0.38	1.0 x 0.6 x 0.5
RClamp0521PA	5.0	1	±15kV/±12kV	4	0.5	1.0 x 0.6 x 0.5
RClamp0531T	5.0	1	±20kV/±12kV	4	0.8	1.0 x 0.6 x 0.4
RClamp2451ZA	24	1	±18kV/±14kV	4	0.45	0.6 x 0.3 x 0.25
RClamp1521P	15	1	±15kV/±8kV	4	0.5	1.0 x 0.6 x 0.5

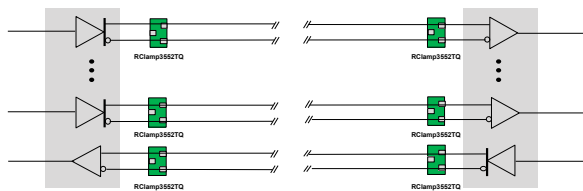

Low Voltage Differential Signaling (LVDS)						
Part Number	V _{RWM} (V)	Lines	ESD Rating (Air/Contact)	Surge (8x20us) (A)	Cap (pF)	Size (mm)
RClamp3552TQ	3.5	2	±20kV/±17kV	4	0.4	1.0 x 0.6 x 0.4
RClamp3331PQ	3.3	1	±30kV/±30kV	10	0.38	1.0 x 0.6 x 0.5

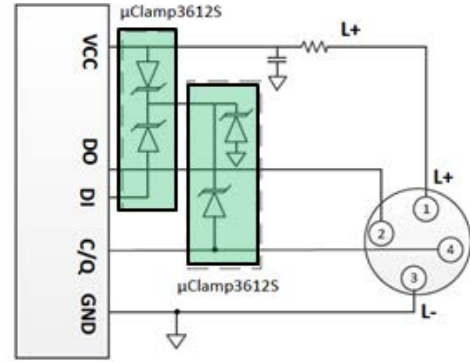
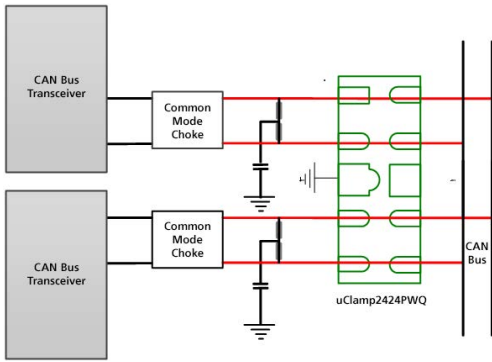

CAN Bus Protection

Part Number	V _{RWM} (V)	Lines	ESD Rating (Air/Contact)	Surge (8x20us) (A)	Cap (pF)	Size (mm)
 μClamp2424PWQ	24	2	±30kV/±30kV	5A	115	2.5 x 1.0 x 0.55

USB VBUS

Part Number	V _{RWM} (V)	Lines	ESD Rating (Air/Contact)	Surge (8x20us) (A)	Cap (pF)	Size (mm)
PCLamp0501P	5	1	±30kV/±30kV	120	1150	1.6 x 1.0 x 0.53
PCLamp1021P	10	1	±30kV/±30kV	80	600	1.6 x 1.0 x 0.53
PCLamp1211P	13.5	1	±30kV/±30kV	180	2500	2.0 x 1.8 x 0.57
PCLamp1221P	12	1	±30kV/±30kV	80	530	1.6 x 1.0 x 0.53
PCLamp1011P	10	1	±30kV/±30kV	180	2500	2.0 x 1.8 x 0.57
PCLamp2011P	23	1	±30kV/±30kV	120	800	2.0 x 1.8 x 0.57

IO-Link & Proximity Switch Protection

Part Number	V _{RWM} (V)	Lines	ESD Rating (Air/Contact)	Surge (8x20us) (A)	Cap (pF)	Size (mm)
SDC36C	33	2	±15kV/±8kV	4	120	3.04 x 2.64 x 1.2
μClamp3603T	36	3	±20kV/±15kV	16	120	1.7 x 1.0 x 0.4

VBUS Protection

Part Number	V _{RWM} (V)	Lines	ESD Rating (Air/Contact)	Surge (8x20us) (A)	Cap (pF)	Size (mm)
μClamp0571P	5	1	±30kV/±30kV	80	675	1.6 x 1.0 x 0.57
μClamp0871P	8	1	±30kV/±30kV	65	475	1.6 x 1.0 x 0.57
μClamp1071P	10	1	±30kV/±30kV	60	350	1.6 x 1.0 x 0.57
μClamp1271P	12	1	±30kV/±30kV	45	275	1.6 x 1.0 x 0.57
μClamp1571P	15	1	±30kV/±30kV	40	220	1.6 x 1.0 x 0.57
μClamp1871P	18	1	±30kV/±30kV	35	225	1.6 x 1.0 x 0.57
μClamp2271P	22	1	±30kV/±30kV	25	165	1.6 x 1.0 x 0.57
μClamp2671P	26	1	±30kV/±30kV	23	155	1.6 x 1.0 x 0.57
μClamp3671P	36	1	±30kV/±30kV	18	150	1.6 x 1.0 x 0.57

Optical Modules Protection

Part Number	V _{RWM} (V)	Lines	ESD Rating (Air/Contact)	Surge (8x20us) (A)	Cap (pF)	Size (mm)
μClamp0511P	5	1	±15kV/±8kV	12	75	1.0 x 0.6 x 0.5
μClamp3381P	3.3	1	±30kV/±30kV	25	35	1.0 x 0.6 x 0.5
RCLamp7524T	5	4	±30kV/±25kV	5	0.6	1.3 x 0.8 x 0.4
RCLamp0524T	5	4	±15kV/±8kV	5	0.8	2.5 x 1.0 x 0.4



For a detailed list of sales representatives
in your area please visit [semtech.com/sales](https://www.semtech.com/sales)



Semtech Corporation is a leading global supplier of high performance analog and mixed-signal semiconductors and advanced algorithms for infrastructure, high-end consumer and industrial equipment. Products are designed to benefit the engineering community as well as the global community. The Company is dedicated to reducing the impact it, and its products, have on the environment. Internal green programs seek to reduce waste through material and manufacturing control, use of green technology and designing for resource reduction. Publicly traded since 1967, Semtech is listed on the NASDAQ Global Select Market under the symbol SMTC. For more information, visit www.semtech.com.

200 Flynn Road, Camarillo, California 93012 | 805-498-2111

semtech.com |     Find us, like us, follow us